

INSTRUCTION MANUAL

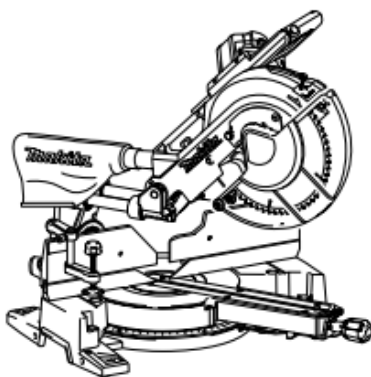

Slide Compound Miter Saw

LS1216
LS1216L
LS1216F
LS1216FL



010049

DOUBLE INSULATION

IMPORTANT: Read Before Using.

ENGLISH (Original instructions)

SPECIFICATIONS

Model	LS1216/ LS1216L/ LS1216F/ LS1216FL
Blade diameter	305 mm
Blade body thickness	1.6 mm - 2.4 mm
Hole diameter	European countries: 30 mm, other than European countries: 25.4 mm
Max. Miter angle	Left 52°, Right 60°
Max. Bevel angle	Left and Right 45°
Max. Cutting capacities (H x W)	

Miter angle		Bevel angle		
		45°(left)	0°	45°(right)
0°		59mm×382mm 69mm×363mm	87mm×382mm 102mm×363mm	44mm×382mm 54mm×363mm
	Thickness of wood facing on guide fence for increased height of cut	35mm	78mm×290 mm	115mm×300mm 61mm×290mm
		60mm	—	120mm×250mm —
45°(left and right)		59mm×268mm 69mm×255mm	87mm×268mm 102mm×255mm	44mm×268mm 54mm×255mm
	Thickness of wood facing on guide fence for increased height of cut	30mm	—	115mm×202mm —
		45mm	—	120mm×172mm —
52°(left and right)		—	87mm×233mm 102mm×220mm	—
	Thickness of wood facing on guide fence for increased height of cut	25mm	—	115mm×178mm —
		35mm	—	120mm×155mm —
60°(right)		—	87mm×185mm 102mm×178mm	—
	Thickness of wood facing on guide fence for increased height of cut	25mm	—	115mm×140mm —
		35mm	—	120mm×122mm —

Special Max. Cutting capacities

Crown molding 45° type (with Crown molding stopper used)	203 mm
Base board (H) (with Horizontal vise used)	165 mm

Special Max Width Cutting Capacities

(with 38 mm (1-1/2") thick platform used)

Bevel angle	Miter angle	Max. cutting
0°	0°	416 mm
	45° (Left and right)	292 mm

Refer to OPERATION for the cutting procedure.

No load speed (min⁻¹)

3,200

Laser Type (LS1216L,LS1216FL only)

Red Laser 650 nm, < 1.6mW (Laser Class 2M)

Dimensions (L x W x H)

806 mm x 640 mm x 721 mm

Net weight

For all countries other than European countries

LS1216...26.3 kg
LS1216L/LS1216F ...26.4 kg
LS1216FL ...26.5 kg

For European countries

LS1216...26.5 kg
LS1216L/LS1216F ...26.6 kg
LS1216FL ...26.7 kg

Safety class

- Due to our continuing program of research and development, the specifications herein are subject to change without notice.
- Note: Specifications may differ from country to country.
- Weight according to EPTA-Procedure 1/2003

END210-6

ENF002-2

Symbols

The following show the symbols used for the equipment. Be sure that you understand their meaning before use.



- Read instruction manual.



- DOUBLE INSULATION



- To avoid injury from flying debris, keep holding the saw head down, after making cuts, until the blade has come to a complete stop.



- When performing slide cut, first pull carriage fully and press down handle, then push carriage toward the guide fence.



- Do not place hand or fingers close to the blade.



- Never look into the laser beam. Direct laser beam may injure your eyes.



- Only for EU countries

Do not dispose of electric equipment together with household waste material! In observance of European Directive 2002/96/EC on waste electric and electronic equipment and its implementation in accordance with national law, electric equipment that have reached the end of their life must be collected separately and returned to an environmentally compatible recycling facility.

ENED06-1

Intended use

The tool is intended for accurate straight and miter cutting in wood. With appropriate saw blades, aluminum can also be sawed.

Power supply

The tool should be connected only to a power supply of the same voltage as indicated on the nameplate, and can only be operated on single-phase AC supply. They are double-insulated and can, therefore, also be used from sockets without earth wire.

ENG905-1

Noise

The typical A-weighted noise level determined according to EN61029:

Sound pressure level (L_{pa}): 91 dB(A)

Sound power level (L_{wa}): 100 dB(A)

Uncertainty (K): 3 dB(A)

Wear ear protection

ENG900-1

Vibration

The vibration total value (tri-axial vector sum) determined according to EN61029:

Vibration emission (a_n): 2.5 m/s^2 or less

Uncertainty (K): 1.5 m/s^2

ENG901-1

- The declared vibration emission value has been measured in accordance with the standard test method and may be used for comparing one tool with another.
- The declared vibration emission value may also be used in a preliminary assessment of exposure.

WARNING:

- The vibration emission during actual use of the power tool can differ from the declared emission value depending on the ways in which the tool is used.
- Be sure to identify safety measures to protect the operator that are based on an estimation of exposure in the actual conditions of use (taking account of all parts of the operating cycle such as

the times when the tool is switched off and when it is running idle in addition to the trigger time).

ENH003-13

For European countries only

EC Declaration of Conformity

We Makita Corporation as the responsible manufacturer declare that the following Makita machine(s):

Designation of Machine:

Slide Compound Miter Saw

Model No./ Type: LS1216, LS1216L, LS1216F,

LS1216FL

are of series production and

Conforms to the following European Directives:

2006/42/EC

And are manufactured in accordance with the following standards or standardised documents:

EN61029

The technical documentation is kept by our authorised representative in Europe who is:

Makita International Europe Ltd.

Michigan Drive, Tongwell,

Milton Keynes, Bucks MK15 8JD, England

20. 1. 2010



000230

Tomoyasu Kato

Director

Makita Corporation

3-11-8, Sumiyoshi-cho,
Anjo, Aichi, 446-8502, JAPAN

ENAD01-2

SAFETY INSTRUCTIONS

WARNING! When using electric tools, basic safety precautions, including the following, should always be followed to reduce the risk of fire, electric shock and personal injury. Read all these instructions before operating this product and save these instructions.

For safe operations:

- 1. Keep work area clean.**
Cluttered areas and benches invite injuries.
- 2. Consider work area environment.**
Do not expose power tools to rain. Do not use power tools in damp or wet locations. Keep work area well lit. Do not use power tools where there is risk to cause fire or explosion.

- 3. Guard against electric shock.**
Avoid body contact with earthed or grounded surfaces (e.g. pipes, radiators, ranges, refrigerators).
- 4. Keep children away.**
Do not let visitors touch the tool or extension cord. All visitors should be kept away from work area.
- 5. Store idle tools.**
When not in use, tools should be stored in a dry, high or locked up place, out of reach of children.
- 6. Do not force the tool.**
It will do the job better and safer at the rate for which it was intended.
- 7. Use the right tool.**
Do not force small tools or attachments to do the job of a heavy duty tool. Do not use tools for purposes not intended; for example, do not use circular saws to cut tree limbs or logs.
- 8. Dress properly.**
Do not wear loose clothing or jewellery, they can be caught in moving parts. Rubber gloves and non-skid footwear are recommended when working outdoors. Wear protecting hair covering to contain long hair.
- 9. Use safety glasses and hearing protection.**
Also use face or dust mask if the cutting operation is dusty.
- 10. Connect dust extraction equipment.**
If devices are provided for the connection of dust extraction and collection facilities ensure these are connected and properly used.
- 11. Do not abuse the cord.**
Never carry the tool by the cord or yank it to disconnect it from the socket. Keep the cord away from heat, oil and sharp edges.
- 12. Secure work.**
Use clamps or a vice to hold the work. It is safer than using your hand and it frees both hands to operate the tool.
- 13. Do not overreach.**
Keep proper footing and balance at all times.
- 14. Maintain tools with care.**
Keep cutting tools sharp and clean for better and safer performance. Follow instructions for lubrication and changing accessories. Inspect tool cord periodically and if damaged have it repaired by an authorized service facility. Inspect extension cords periodically and replace, if damaged. Keep handles dry, clean and free from oil and grease.
- 15. Disconnect tools.**
When not in use, before servicing and when changing accessories such as blades, bits and cutters.

16. **Remove adjusting keys and wrenches.**
Form the habit of checking to see that keys and adjusting wrenches are removed from the tool before turning it on.
 17. **Avoid unintentional starting.**
Do not carry a plugged-in tool with a finger on the switch. Ensure switch is off when plugging in.
 18. **Use outdoor extension leads.**
When tool is used outdoors, use only extension cords intended for outdoor use.
 19. **Stay alert.**
Watch what you are doing. Use common sense. Do not operate tool when you are tired.
 20. **Check damaged parts.**
Before further use of the tool, a guard or other part that is damaged should be carefully checked to determine that it will operate properly and perform its intended function. Check for alignment of moving parts, free running of moving parts, breakage of parts, mounting and any other conditions that may affect its operation. A guard or other part that is damaged should be properly repaired or replaced by an authorized service center unless otherwise indicated in this instruction manual. Have defective switches replaced by an authorized service facility. Do not use the tool if the switch does not turn it on and off.
 21. **Warning.**
The use of any accessory or attachment, other than those recommended in this instruction manual or the catalog, may present a risk of personal injury.
 22. **Have your tool repaired by a qualified person.**
This electric tool is in accordance with the relevant safety requirements. Repairs should only be carried out by qualified persons using original spare parts, otherwise this may result in considerable danger to the user.
4. **Do not perform any operation freehand.** The workpiece must be secured firmly against the turn base and guide fence with the vise during all operations. Never use your hand to secure the workpiece.
 5. **Never reach around saw blade.**
 6. **Turn off tool and wait for saw blade to stop before moving workpiece or changing settings.**
 7. **Unplug tool before changing blade or servicing.**
 8. **Always secure all moving portions before carrying the tool.**
 9. **Stopper pin which locks the cutter head down is for carrying and storage purposes only and not for any cutting operations.**
 10. **Do not use the tool in the presence of flammable liquids or gases.** The electrical operation of the tool could create an explosion and fire when exposed to flammable liquids or gases.
 11. **Check the blade carefully for cracks or damage before operation. Replace cracked or damaged blade immediately.**
 12. **Use only flanges specified for this tool.**
 13. **Be careful not to damage the arbor, flanges (especially the installing surface) or bolt. Damage to these parts could result in blade breakage.**
 14. **Make sure that the turn base is properly secured so it will not move during operation.**
 15. **For your safety, remove the chips, small pieces, etc. from the table top before operation.**
 16. **Avoid cutting nails. Inspect for and remove all nails from the workpiece before operation.**
 17. **Make sure the shaft lock is released before the switch is turned on.**
 18. **Be sure that the blade does not contact the turn base in the lowest position.**
 19. **Hold the handle firmly. Be aware that the saw moves up or down slightly during start-up and stopping.**
 20. **Make sure the blade is not contacting the workpiece before the switch is turned on.**
 21. **Before using the tool on an actual workpiece, let it run for a while. Watch for vibration or wobbling that could indicate poor installation or a poorly balanced blade.**
 22. **Wait until the blade attains full speed before cutting.**
 23. **Stop operation immediately if you notice anything abnormal.**

ENB034-6

ADDITIONAL SAFETY RULES FOR TOOL

1. **Wear eye protection.**
 2. **Keep hands out of path of saw blade. Avoid contact with any coasting blade. It can still cause severe injury.**
 3. **Do not operate saw without guards in place. Check blade guard for proper closing before each use. Do not operate saw if blade guard does not move freely and close instantly. Never clamp or tie the blade guard into the open position.**
23. **Stop operation immediately if you notice anything abnormal.**

24. Do not attempt to lock the trigger in the on position.
25. Be alert at all times, especially during repetitive, monotonous operations. Do not be lulled into a false sense of security. Blades are extremely unforgiving.
26. Always use accessories recommended in this manual. Use of improper accessories such as abrasive wheels may cause an injury.
27. Do not use the saw to cut other than wood, aluminum or similar materials.
28. Connect miter saws to a dust collecting device when sawing.
29. Select saw blades in relation to the material to be cut.
30. Take care when slotting.
31. Replace the kerf board when worn.
32. Do not use saw blades manufactured from high speed steel.
33. Some dust created from operation contains chemicals known to cause cancer, birth defects or other reproductive harm. Some examples of these chemicals are:
 - lead from lead-based-painted material and,
 - arsenic and chromium from chemically-treated lumber.

Your risk from these exposures varies, depending on how often you do this type of work. To reduce your exposure to these chemicals: work in a well ventilated area and work with approved safety equipment, such as those dust masks that are specially designed to filter out microscopic particles.
34. To reduce the emitted noise, always be sure that the blade is sharp and clean.
35. The operator is adequately trained in the use, adjustment and operation of the machine.
36. Use correctly sharpened saw blades. Observe the maximum speed marked on the saw blade.
37. Refrain from removing any cut-offs or other parts of the workpiece from the cutting area whilst the tool is running and the saw head is not in the rest position.
38. Use only saw blades recommended by the manufacturer which conform to EN847-1.
39. Wear gloves for handling saw blade (saw blades shall be carried in a holder wherever practicable) and rough material.
40. When fitted with laser, no exchange with different type of laser is permitted. Repairs shall only be carried out correctly.

SAVE THESE INSTRUCTIONS.

INSTALLATION

Bench mounting

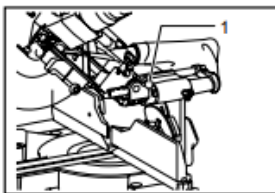

1. Stopper pin

009483

When the tool is shipped, the handle is locked in the lowered position by the stopper pin. Release the stopper pin by simultaneously applying a slight downward pressure on the handle and pulling the stopper pin.

⚠WARNING:

- Ensure that the tool will not move on the supporting surface. Movement of the miter saw on the supporting surface while cutting may result in loss of control and serious personal injury.

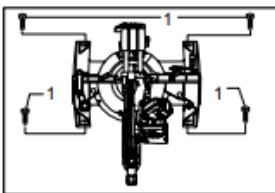

1. Hex bolts

010593

This tool should be bolted with four bolts to a level and stable surface using the bolt holes provided in the tool's base. This will help prevent tipping and possible injury.

FUNCTIONAL DESCRIPTION

⚠WARNING:

- Always be sure that the tool is switched off and unplugged before adjusting or checking function on the tool. Failure to switch off and unplug the tool may result in serious personal injury from accidental start-up.

Blade guard

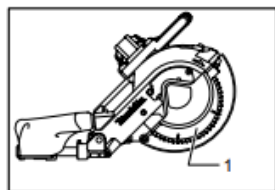

1. Blade guard

009485

When lowering the handle, the blade guard rises automatically. The blade guard returns to its original position when the cut is completed and the handle is raised.

⚠WARNING:

- Never defeat or remove the blade guard or the spring which attaches to the guard. An exposed blade as a result of defeated guarding may result in serious personal injury during operation.

In the interest of your personal safety, always maintain the blade guard in good condition. Any irregular operation of the blade guard should be corrected immediately. Check to assure spring loaded return action of guard.

⚠WARNING:

- Never use the tool if the blade guard or spring are damaged, faulty or removed. Operation of the tool with a damaged, faulty or removed guard may result in serious personal injury.

If the see-through blade guard becomes dirty, or sawdust adheres to it in such a way that the blade and/or workpiece is no longer easily visible, unplug the saw and clean the guard carefully with a damp cloth. Do not use solvents or any petroleum-based cleaners on the plastic guard because this may cause damage to the guard. If the blade guard becomes dirty and needs to be cleaned for proper operation follow the steps below:

With the tool switched off and unplugged, use the supplied socket wrench to loosen the hex bolt holding the center cover. Loosen the hex bolt by turning it counterclockwise and raise the blade guard and center cover.

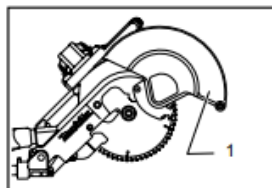

1. Blade guard

009486

With the blade guard so positioned, cleaning can be more completely and efficiently accomplished. When cleaning is complete reverse procedure above and secure bolt. Do not remove spring holding blade guard. If guard becomes damaged through age or UV light exposure, contact a Makita service center for a new guard. **DO NOT DEFEAT OR REMOVE GUARD.**

Positioning kerf board

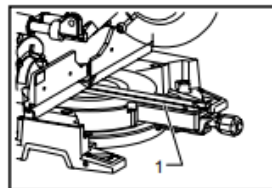

1. Kerf board

009488

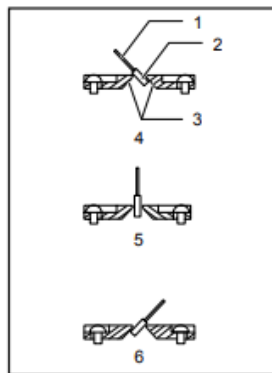

1. Saw blade
2. Blade teeth
3. Kerf board
4. Left bevel cut
5. Straight cut
6. Right bevel cut

001538

This tool is provided with the kerf boards in the turn base to minimize tearing on the exit side of a cut. The kerf boards are factory adjusted so that the saw blade does not contact the kerf boards. Before use, adjust the kerf boards as follows:

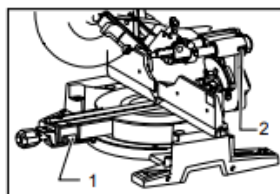

1. Lock lever
2. Locking screw

005496

First, unplug the tool. Loosen all the screws (3 each on left and right) securing the kerf boards. Re-tighten them only to the extent that the kerf boards can still be easily moved by hand. Lower the handle fully and push in the stopper pin to lock the handle in the lowered position. Loosen the locking screw counterclockwise which secures the upper slide poles and also push forward the lock lever which secures the lower slide poles. Pull the carriage toward you fully. Adjust the kerf boards so that the kerf boards just contact the sides of the blade teeth. Tighten the front screws (do not tighten firmly). Push the carriage toward the guide fence fully and adjust the kerf boards so that the kerf boards just contact the sides of blade teeth. Tighten the rear screws (do not tighten firmly).

After adjusting the kerf boards, release the stopper pin and raise the handle. Then tighten all the screws securely.

NOTICE:

- After setting the bevel angle ensure that the kerf boards are adjusted properly. Correct adjustment of the kerf boards will help provide proper support of the workpiece minimizing workpiece tear out.

Maintaining maximum cutting capacity

This tool is factory adjusted to provide the maximum cutting capacity for a 305mm saw blade.

Unplug the tool before any adjustment is attempted. When installing a new blade, always check the lower limit position of the blade and if necessary, adjust it as follows:

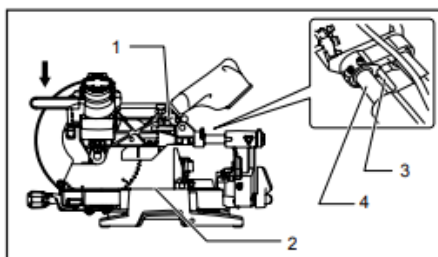

1. Adjusting bolt
2. Turn base
3. Stopper lever
4. Slide pipe

009518

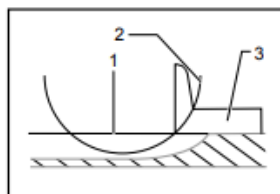

1. Top surface of turn base
2. Periphery of blade
3. Guide fence

009737

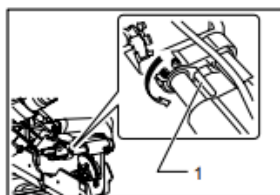

1. Stopper lever

009736

First, unplug the tool. Lower the stopper lever to position the saw blade as shown in the figure. Push the carriage toward the guide fence fully and lower the handle completely. Use the socket wrench to turn the adjusting bolt until the periphery of the blade extends slightly below the top surface of the turn base at the point where the front face of the guide fence meets the top surface of the turn base.

With the tool unplugged, rotate the blade by hand while holding the handle all the way down to be sure that the blade does not contact any part of the lower base. Re-adjust slightly, if necessary.

After adjustment, always return the stopper lever to the original position by turning it counterclockwise.

⚠WARNING:

- After installing a new blade and with the tool unplugged, always be sure that the blade does not contact any part of the lower base when

the handle is lowered completely. If a blade makes contact with the base it may cause kickback and result in serious personal injury.

Stopper arm

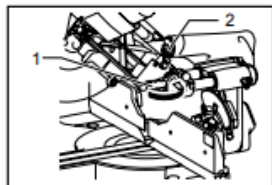

1. Stopper arm
2. Adjusting screw

009487

The lower limit position of the blade can be easily adjusted with the stopper arm. To adjust it, rotate the stopper arm in the direction of the arrow as shown in the figure. Adjust the adjusting screw so that the blade stops at the desired position when lowering the handle fully.

Adjusting the miter angle

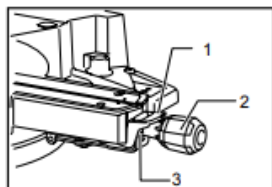

1. Lock lever
2. Grip
3. Cam

009517

Push the grip so that the cam engages and turn it clockwise until it stops. Turn the turn base while pressing down the lock lever. When you have moved the grip to the position where the pointer points to the desired angle on the miter scale, turn the grip 90° counterclockwise to lock the turn base.

⚠CAUTION:

- After changing the miter angle, always secure the turn base by turning the grip 90° counterclockwise.

NOTICE:

- When turning the turn base, be sure to raise the handle fully.

Adjusting the bevel angle

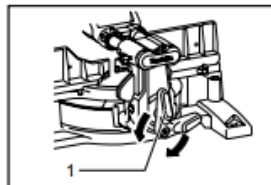

1. Lever

009489

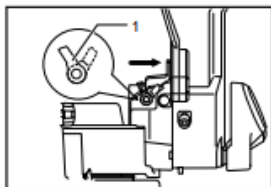

1. Latch lever

010322

To adjust the bevel angle, loosen the lever at the rear of the tool counterclockwise. Push the latch lever forward as shown in the figure fully while supporting the weight of the saw head so as to release the pressure on the lock pin.

When tilting the carriage to the right, tilt the carriage to the left slightly after loosening the lever and press the releasing button. With the releasing button being pressed, tilt the carriage to the right.

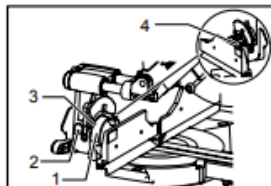

1. Scale plate
2. Release button
3. Pointer
4. Latch lever

009513

Tilt the saw blade until the pointer points to the desired angle on the bevel scale. Then tighten the lever clockwise firmly to secure the arm.

When the latch lever is pulled towards the front of the saw, the saw blade can be locked using positive stops at the right and left 22.5° and 33.9° angle to the base surface.

When the latch lever is pushed to the back of the saw as shown in the figure, the saw blade can be locked at any desired angle within the specified bevel angle range.

⚠CAUTION:

- After changing the bevel angle, always secure the arm by tightening the lever clockwise.

NOTICE:

- When tilting the saw blade be sure the handle is fully raised.
- When changing bevel angles, be sure to position the kerf boards appropriately as explained in the "Positioning kerf boards" section.

Slide lock adjustment

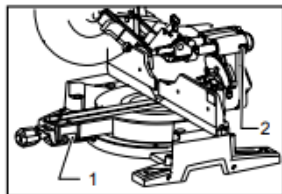

- Lock lever
- Locking screw

009496

To lock the lower slide pole, pull the lock lever towards the front of the saw.

To lock the upper slide pole, turn the locking screw clockwise.

Switch action

For European countries

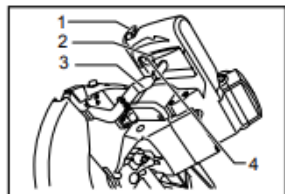

- Lock-off button
- Switch trigger
- Lever
- Hole for padlock

009886

To prevent the switch trigger from being accidentally pulled, a lock-off button is provided. To start the tool, push the lever to the left, press in the lock-off button and then pull the switch trigger. Release the switch trigger to stop.

⚠WARNING:

- Before plugging in the tool, always check to see that the switch trigger actuates properly and returns to the "OFF" position when released. Do not pull the switch trigger hard without pressing in the lock-off button. This can cause switch breakage. Operating a tool with a switch that does not actuate properly can lead to loss of control and serious personal injury.
- A hole is provided in the switch trigger for insertion of padlock to lock the tool off.

For all countries other than European countries

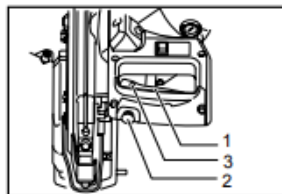

- Switch trigger
- Lock-off button
- Hole for padlock

009491

To prevent the switch trigger from being accidentally pulled, a lock-off button is provided. To start the tool, press in the lock-off button and pull the switch trigger. Release the switch trigger to stop.

⚠WARNING:

- Before plugging in the tool, always check to see that the switch trigger actuates properly and returns to the "OFF" position when released. Do not pull the switch trigger hard without pressing in the lock-off button. This can cause switch breakage. Operating a tool with a switch that does not actuate properly can lead to loss of control and serious personal injury.
- A hole is provided in the switch trigger for insertion of padlock to lock the tool off.

⚠WARNING:

- Do not use a lock with a shank or cable any smaller than 6.35 mm in diameter. A smaller shank or cable may not properly lock the tool in the off position and unintentional operation may occur resulting in serious personal injury.
- NEVER use tool without a fully operative switch trigger. Any tool with an inoperative switch is HIGHLY DANGEROUS and must be repaired before further usage or serious personal injury may occur.
- For your safety, this tool is equipped with a lock-off button which prevents the tool from unintended starting. NEVER use the tool if it runs when you simply pull the switch trigger without pressing the lock-off button. A switch in need of repair may result in unintentional operation and serious personal injury. Return tool to a Makita service center for proper repairs BEFORE further usage.
- NEVER defeat the lock-off button by taping down or some other means. A switch with a defeated lock-off button may result in unintentional operation and serious personal injury.

Lighting up the lamps

For Models LS1216F and LS1216FL only

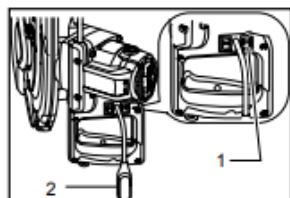

1. Switch for light
2. Light

010633

⚠ CAUTION:

- This is not a rainproof light. Do not wash the light in water or use it in a rain or a wet area. Such a conduct can cause an electric shock and fume.
- Do not touch the lens of the light, as it is very hot while it is lighted or shortly after it is turned off. This may cause a burn to a human body.
- Do not apply impact to the light, which may cause damage or shorted service time to it.
- Do not keep casting the beam of the light to your eyes. This can cause your eyes to be hurt.
- Do not cover the light with clothes, carton, cardboard or similar objects while it is lighted, which can cause a fire or an ignition.

To turn on the light, press the upper position (I) of the switch. To turn off the light, press the lower position (O) of the switch.

Move the light to shift an area of lighting.

NOTE:

- Use a dry cloth to wipe the dirt off the lens of lamp. Be careful not to scratch the lens of light, or it may lower the illumination.

Electronic function

Constant speed control

- The tool is provided with an electronic speed control which helps maintain a constant blade rotation speed even under load. A constant blade rotation speed will result in a very smooth cut.

Soft start feature

- This function allows the smooth start-up of the tool by limiting the start-up torque.

Laser beam action

For models LS1216L and LS1216FL only

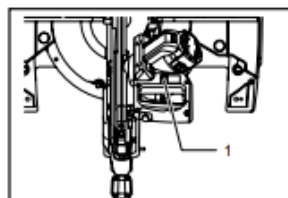

1. Switch for laser

009492

⚠ CAUTION:

- Never look into the laser beam. Direct laser beam may injure your eyes.
- LASER RADIATION, DO NOT STARE INTO THE BEAM OR VIEW DIRECTLY WITH OPTICAL INSTRUMENTS. CLASS 2M LASER PRODUCT.

To turn on the laser beam, press the upper position (I) of the switch. To turn off the laser beam, press the lower position (O) of the switch.

Laser line can be shifted to either the left or right side of the saw blade by adjusting the adjusting screw as follows.

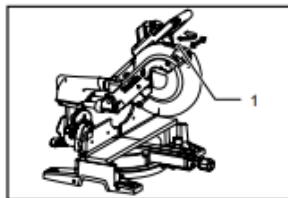

1. Adjusting screw

009493

1. Loosen the adjusting screw by turning it counterclockwise.
2. With the adjusting screw loosened, slide the adjusting screw to the right or left as far as it goes.
3. Tighten the adjusting screw firmly at the position where it stops sliding.

Laser line is factory adjusted so that it is positioned within 1 mm from the side surface of the blade (cutting position).

NOTE:

- When laser line appears dim and hard to see because of direct sunlight, relocate the work area to a place where there is less direct sunlight.

Aligning the laser line

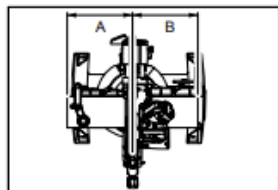

009434

Laser line can be shifted to either the left or right side of the blade according to the applications of cutting. Refer to explanation titled "Laser beam action" regarding its shifting method.

NOTE:

- Use wood facing against the guide fence when aligning the cutting line with the laser line at the side of guide fence in compound cutting (bevel angle 45 degrees and miter angle right 45 degrees).

A) When you obtain the correct size on the left side of workpiece

- Shift the laser line to the left of the blade.

B) When you obtain the correct size on the right side of workpiece

- Shift the laser line to the right of the blade.

Align the cutting line on your workpiece with the laser line.

ASSEMBLY

⚠WARNING:

- Always be sure that the tool is switched off and unplugged before working on the tool. Failure to switch off and unplug the tool may result in serious personal injury.

Storing wrench

For model with hex wrench

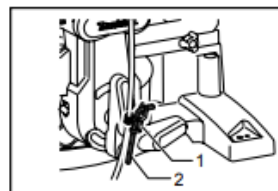

012597

The hex wrench is stored as shown in the figure. When the hex wrench is needed it can be pulled out of the wrench holder.

After using the hex wrench it can be stored by returning it to the wrench holder.

1. Wrench holder
2. Hex wrench

For model with socket wrench

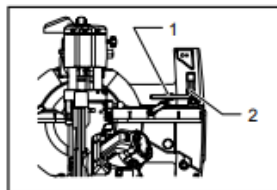

009435

The socket wrench is stored as shown in the figure. When the socket wrench is needed it can be pulled out of the wrench holder.

After using the socket wrench it can be stored by returning it to the wrench holder.

Installing or removing saw blade

⚠WARNING:

- Always be sure that the tool is switched off and unplugged before installing or removing the blade. Accidental start up of the tool may result in serious personal injury.

For model with hex wrench

⚠WARNING:

- Use only the Makita hex wrench provided to install or remove the blade. Failure to use the wrench may result in overtightening or insufficient tightening of the hex socket bolt and serious personal injury.

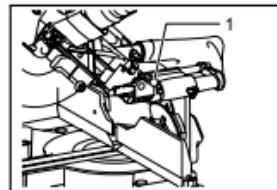

009483

Lock the handle in the raised position by pushing in the stopper pin.

1. Stopper pin

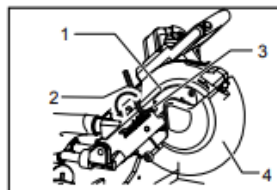

012591

1. Center cover
2. Hex wrench
3. Hex socket bolt
4. Blade guard

To remove the blade, use the hex wrench to loosen the hex socket bolt holding the center cover by turning it counterclockwise. Raise the blade guard and center cover.

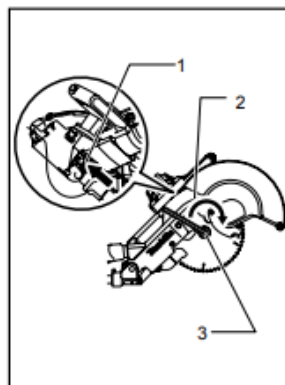

1. Shaft lock
2. Blade case
3. Hex socket bolt

012592

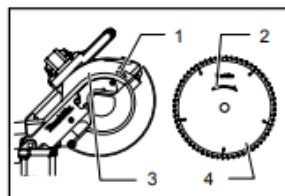

1. Arrow
2. Arrow
3. Blade case
4. Saw blade

009500

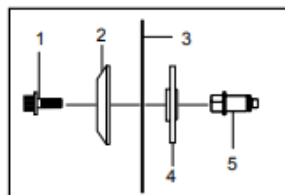

1. Hex socket bolt
2. Outer flange
3. Saw blade
4. Inner flange
5. Spindle

013265

Press the shaft lock to lock the spindle and use the hex wrench to loosen the hex socket bolt clockwise. Then remove the hex socket bolt, outer flange and blade.

NOTE:

- In some countries, tools have a ring separated from an inner flange. If the inner flange is removed be sure to install it on the spindle with its protrusion facing away from the blade. If the flange is installed incorrectly the flange will rub against the machine.

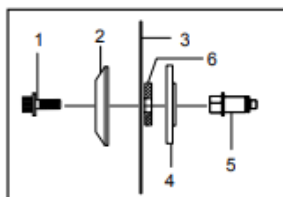

012594

⚠WARNING:

- Before mounting the blade onto the spindle, always be sure that the correct inner flange or ring for the blade's arbor hole you intend to use is installed. Use of the incorrect inner flange or ring may result in the improper mounting of the blade causing blade movement and severe vibration resulting in possible loss of control during operation and in serious personal injury.

To install the blade, mount it carefully onto the spindle, making sure that the direction of the arrow on the surface of the blade matches the direction of the arrow on the blade case.

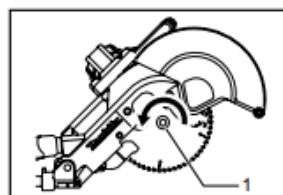

012593

Install the outer flange and hex socket bolt, and then use the hex wrench to tighten the hex socket bolt (left-handed) securely counterclockwise while pressing the shaft lock.

Return the blade guard and center cover to its original position. Then tighten the hex socket bolt clockwise to secure the center cover. Release the handle from the raised position by pulling the stopper pin. Lower the handle to make sure that the blade guard moves properly. Make sure the shaft lock has released spindle before making cut.

For model with socket wrench

⚠WARNING:

- Use only the Makita socket wrench provided to install or remove the blade. Failure to use the wrench may result in overtightening or insufficient tightening of the hex bolt and serious personal injury.

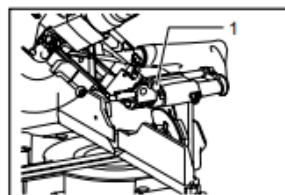

1. Stopper pin

009483

Lock the handle in the raised position by pushing in the stopper pin.

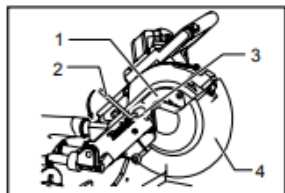

1. Center cover
2. Socket wrench
3. Hex bolt
4. Blade guard

009497

To remove the blade, use the socket wrench to loosen the hex bolt holding the center cover by turning it counterclockwise. Raise the blade guard and center cover.

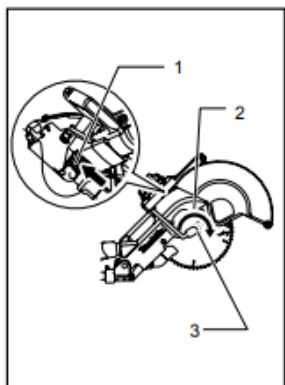

1. Shaft lock
2. Blade case
3. Hex bolt

009498

Press the shaft lock to lock the spindle and use the socket wrench to loosen the hex bolt clockwise. Then remove the hex bolt, outer flange and blade.

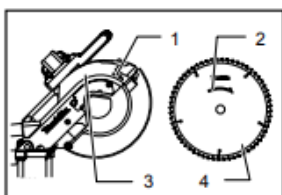

1. Arrow
2. Arrow
3. Blade case
4. Saw blade

009500

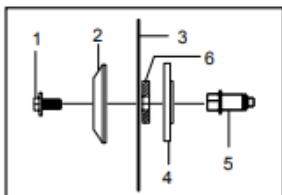

1. Hex bolt
2. Outer flange
3. Saw blade
4. Inner flange
5. Spindle
6. Ring

009925

NOTE:

- If the inner flange is removed be sure to install it on the spindle with its protrusion facing away from the blade. If the flange is installed incorrectly the flange will rub against the machine.

⚠WARNING:

- **Before mounting the blade onto the spindle, always be sure that the correct ring for the blade's arbor hole you intend to use is installed between the inner and the outer flanges.** Use of the incorrect arbor hole ring may result in the improper mounting of the blade causing blade movement and severe vibration resulting in possible loss of control during operation and in serious personal injury.

To install the blade, mount it carefully onto the spindle, making sure that the direction of the arrow on the surface of the blade matches the direction of the arrow on the blade case.

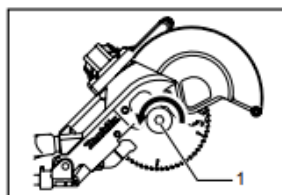

1. Hex bolt

012680

Install the outer flange and hex bolt, and then use the socket wrench to tighten the hex bolt (left-handed) securely counterclockwise while pressing the shaft lock. Return the blade guard and center cover to its original position. Then tighten the hex bolt clockwise to secure

the center cover. Release the handle from the raised position by pulling the stopper pin. Lower the handle to make sure that the blade guard moves properly. Make sure the shaft lock has released spindle before making cut.

Dust bag

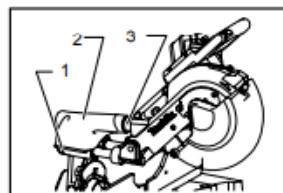

1. Fastener
2. Dust bag
3. Dust nozzle

009501

The use of the dust bag makes cutting operations cleaner and dust collection easier. To attach the dust bag, fit it onto the dust nozzle.

When the dust bag is about half full, remove the dust bag from the tool and pull the fastener out. Empty the dust bag of its contents, tapping it lightly so as to remove particles adhering to the insides which might hamper further collection.

NOTE:

If you connect a vacuum cleaner to your saw, cleaner operations can be performed.

Dust box (Optional accessory)

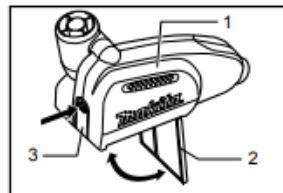

1. Dust box
2. Cover
3. Button

006793

Insert the dust box into the dust nozzle.

Empty the dust box when necessary.

To empty the dust box, open the cover by pushing the button and dispose of the sawdust. Return the cover to the original position and lock it in place. Dust box can easily be removed by pulling it out while turning it near the dust nozzle on the tool.

NOTE:

- If you connect a Makita vacuum cleaner to this tool, cleaner operations can be performed.

NOTICE:

- Empty the dust box before collected sawdust level reaches the cylinder section.

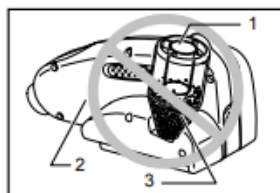

1. Cylinder section
2. Dust box
3. Sawdust

010592

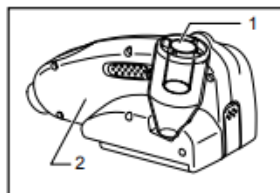

1. Cylinder section
2. Dust box

010591

Securing workpiece

⚠WARNING:

- It is extremely important to always secure the workpiece correctly with the proper type of vise or crown molding stoppers. Failure to do so may result in serious personal injury and cause damage to the tool and/or the workpiece.
- After a cutting operation do not raise the blade until it has come to a complete stop. The raising of a coasting blade may result in serious personal injury and damage to the workpiece.
- When cutting a workpiece that is longer than the support base of the saw, the material should be supported the entire length beyond the support base and at the same height to keep the material level. Proper workpiece support will help avoid blade pinch and possible kickback which may result in serious personal injury. Do not rely solely on the vertical vise and/or horizontal vise to secure the workpiece. This material tends to sag. Support workpiece over its entire length to avoid blade pinch and possible KICKBACK.

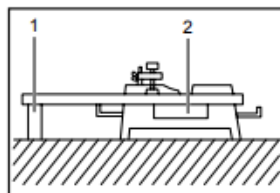

1. Support
2. Turn base

001549

Guide fence (SLIDING FENCES which are upper and lower fences) adjustment

⚠WARNING:

- Before operating the tool, make sure that the upper and lower fences are secured firmly.
- **Before bevel-cutting, make sure that no part of the tool, especially the blade, contacts the upper and lower fences when fully lowering and while moving the carriage through its full range of travel.** If the tool or blade makes contact with the fence this may result in kickback or unexpected movement of the material and serious personal injury.

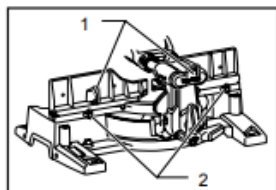

1. Levers
2. Clamping screws

009508

The lower fences can be moved inward and outward by loosening the clamping screws.

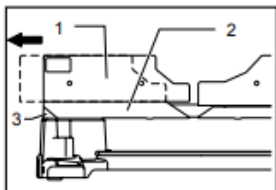

1. Upper fence
2. Lower fence
3. Red indicating area

010594

A red indicating area will appear as the lower fences are moved inward and will disappear as the lower fences are moved outward.

The upper fences can be removed or moved inward and outward by loosening the levers.

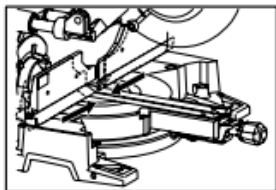

009611

In case of bevel-cutting, adjust the lower and upper fence positions to be as close to the blade as practical to provide maximum workpiece support, and make sure

that no part of the tool, especially the blade, contacts the lower and upper fences when lowering and raising the handle fully at any position and pulling or pushing the carriage all the way at the lowest position.

Before cutting operations, make a dry run with the saw turned off and unplugged, then check clearance between fences and moving parts.

Before cutting operations, firmly secure lower fences by tightening the clamping screws and upper fences by tightening the levers.

When bevel-cutting operations are complete, don't forget to return the upper fences to the original position and return it.

Vertical vise

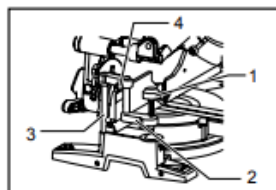

1. Vise knob
2. Vise arm
3. Vise rod
4. Screw

009502

The vertical vise can be installed in two positions on either the left or right side of the base. Insert the vise rod into the hole in the base.

Position the vise arm according to the thickness and shape of the workpiece and secure the vise arm by tightening the screw. If the screw to secure the vise arm contacts the carriage, install the screw on the opposite side of vise arm. Make sure that no part of the tool contacts the vise when lowering the handle fully and pulling or pushing the carriage all the way. If some part contacts the vise, re-position the vise.

Press the workpiece flat against the guide fence and the turn base. Position the workpiece at the desired cutting position and secure it firmly by tightening the vise knob.

Turning the vise knob to 90° counterclockwise allows the vise knob to be moved up and down, facilitating the quick setting of workpiece. To secure the workpiece after setting, turn the vise knob clockwise.

⚠WARNING:

- **The workpiece must be secured firmly against the turn base and guide fence with the vise during all operations.** If the workpiece is not properly secured against the fence the material may move during the cutting operation causing possible damage to the blade, causing the material to be thrown and loss of control resulting in serious personal injury.

Horizontal vise (optional accessory)

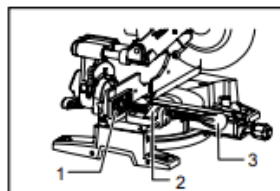

1. Vise plate
2. Vise nut
3. Vise knob

009606

The horizontal vise can be installed in two positions on either the left or right side of the base.

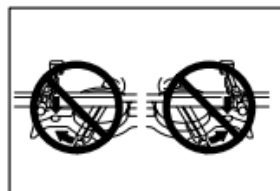

006232

When performing 15° or greater miter cuts, install the horizontal vise on the side opposite the direction in which the turn base is to be turned.

By flipping the vise nut counterclockwise, the vise is released, and rapidly moves in and out. To grip the workpiece, push the vise knob forward until the vise plate contacts the workpiece and flip the vise nut clockwise. Then turn the vise knob clockwise to secure the workpiece.

The maximum width of workpiece which can be secured by the horizontal vise is 215 mm.

⚠WARNING:

- **Always rotate the vise nut clockwise until the workpiece is properly secured.** If the workpiece is not properly secured the material may move during the cutting operation causing possible damage to the blade, causing the material to be thrown and loss of control resulting in serious personal injury.
- When cutting a thin workpiece, such as base boards, against the fence, always use the horizontal vise.

Holders (Optional accessory)

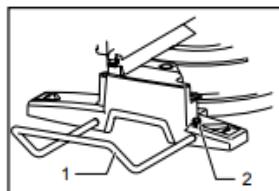

1. Holder
2. Screw

009607

The holders can be installed on either side as a convenient means of holding workpieces horizontally. Slip the holder rods into the holes in the base and adjust their length according to the workpiece to be held. Then tighten the holders securely with the screws.

⚠WARNING:

- **Always support a long workpiece so it is level with the top surface of the turn base for an accurate cut and to prevent dangerous loss of tool control.** Proper workpiece support will help avoid blade pinch and possible kickback which may result in serious personal injury.

OPERATION

NOTICE:

- Before use, be sure to release the handle from the lowered position by pulling the stopper pin.
- Do not apply excessive pressure on the handle when cutting. Too much force may result in overload of the motor and/or decreased cutting efficiency. Push down handle with only as much force as is necessary for smooth cutting and without significant decrease in blade speed.
- Gently press down the handle to perform the cut. If the handle is pressed down with force or if lateral force is applied, the blade will vibrate and leave a mark (saw mark) in the workpiece and the precision of the cut will be impaired.
- During a slide cut, gently push the carriage toward the guide fence without stopping. If the carriage movement is stopped during the cut, a mark will be left in the workpiece and the precision of the cut will be impaired.

⚠WARNING:

- **Make sure the blade is not contacting the workpiece, etc. before the switch is turned on.** Turning the tool on with the blade in contact with the workpiece may result in kickback and serious personal injury.

1. Press cutting (cutting small workpieces)

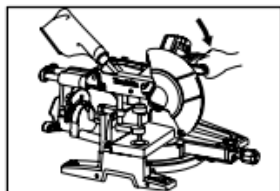

009503

Workpieces up to 87 mm high and 183 mm wide can be cut in the following manner.

After turning the stopper lever clockwise and sliding the carriage to your desired position, push the carriage toward the guide fence fully and tighten the locking screw clockwise and pull the lock lever towards the front of the saw to secure the carriage. Secure the workpiece correctly with the proper type of vise or crown molding stoppers. Switch on the tool without the blade making any contact and wait until the blade attains full speed before lowering. Then gently lower the handle to the fully lowered position to cut the workpiece. When the cut is completed, switch off the tool and WAIT UNTIL THE BLADE HAS COME TO A COMPLETE STOP before returning the blade to its fully elevated position.

⚠WARNING:

- **Firmly tighten the locking screw clockwise and pull the lock lever towards the front of the saw so that the carriage will not move during operation.** Insufficient tightening of the locking screw may cause possible kickback which may result in serious personal injury.

2. Slide (push) cutting (cutting wide workpieces)

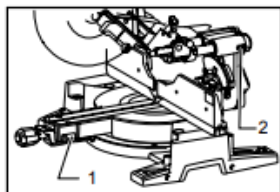

009496

Loosen the locking screw counterclockwise and also push forward the lock lever so that the carriage can slide freely. Secure the workpiece with the proper type of vise.



009504

Pull the carriage toward you fully. Switch on the tool without the blade making any contact and wait until the blade attains full speed. Press the handle down and PUSH THE CARRIAGE TOWARD THE GUIDE FENCE AND THROUGH THE WORKPIECE. When the cut is completed, switch off the tool and WAIT UNTIL THE BLADE HAS COME TO A COMPLETE STOP before returning the blade to its fully elevated position.

⚠WARNING:

- **Whenever performing a slide cut, first pull the carriage full towards you and press the handle all the way down, then push the carriage toward the guide fence. Never start the cut with the carriage not pulled fully toward you.** If you perform the slide cut without the carriage pulled fully toward you unexpected kickback may occur and serious personal injury may result.
 - **Never attempt to perform a slide cut by pulling the carriage towards you.** Pulling the carriage towards you while cutting may cause unexpected kickback resulting in possible serious personal injury.
 - Never perform the slide cut with the handle locked in the lowered position.
 - **Never loosen the knob which secures the carriage while the blade is rotating.** A loose carriage while cutting may cause unexpected kickback resulting in possible serious personal injury.
- ### 3. Miter cutting
- Refer to the previously covered "Adjusting the miter angle".

4. Bevel cut

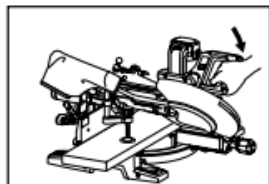

009505

Loosen the lever and tilt the saw blade to set the bevel angle (Refer to the previously covered "Adjusting the bevel angle"). Be sure to retighten the lever firmly to secure the selected bevel angle safely. Secure the workpiece with a vise. Make sure the carriage is pulled all the way back toward the operator. Switch on the tool without the blade making any contact and wait until the blade attains full speed. Then gently lower the handle to the fully lowered position while applying pressure in parallel with the blade and PUSH THE CARRIAGE TOWARD THE GUIDE FENCE TO CUT THE WORKPIECE. When the cut is completed, switch off the tool and WAIT UNTIL THE BLADE HAS COME TO A COMPLETE STOP before returning the blade to its fully elevated position.

⚠ WARNING:

- After setting the blade for a bevel cut, before operating the tool ensure that the carriage and blade will have free travel throughout the entire range of the intended cut. Interruption of the carriage or blade travel during the cutting operation may result in kickback and serious personal injury.
- While making a bevel cut keep hands out of the path of the blade. The angle of the blade may confuse the operator as to the actual blade path while cutting and contact with the blade will result in serious personal injury.
- The blade should not be raised until it has come to a complete stop. During a bevel cut the piece cut off may come to rest against the blade. If the blade is raised while it is rotating the cut-off piece may be ejected by the blade causing the material to fragment which may result in serious personal injury.

NOTICE:

- When pressing down the handle, apply pressure in parallel with the blade. If a force is applied perpendicularly to the turn base or if the pressure direction is changed during a cut, the precision of the cut will be impaired.

- Before bevel-cutting, an adjustment of the upper fence and lower fence maybe required. Refer to the section titled "Guide fence adjustment".

5. Compound cutting

Compound cutting is the process in which a bevel angle is made at the same time in which a miter angle is being cut on a workpiece. Compound cutting can be performed at the angle shown in the table.

Miter angle	Bevel angle
Left and Right 0° - 45°	Left and Right 0° - 45°

009713

When performing compound cutting, refer to "Press cutting", "Slide cutting", "Miter cutting" and "Bevel cut" explanations.

6. Cutting crown and cove moldings

Crown and cove moldings can be cut on a compound miter saw with the moldings laid flat on the turn base.

There are two common types of crown moldings and one type of cove moldings; 52/38° wall angle crown molding, 45° wall angle crown molding and 45° wall angle cove molding. See illustrations.

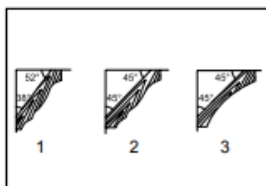

1. 52/38° type crown molding
2. 45° type crown molding
3. 45° type cove molding

001556

There are crown and cove molding joints which are made to fit "Inside" 90° corners ((1) and (2) in Fig. A) and "Outside" 90° corners ((3) and (4) in Fig. A).

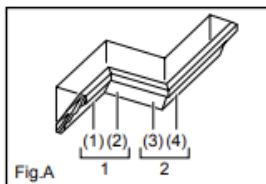
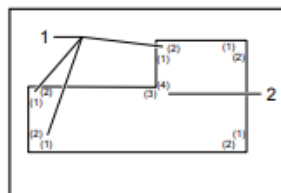

Fig.A

001556

1. Inside corner
2. Outside corner



001557

1. Inside corner
2. Outside corner

Measuring

Measure the wall length and adjust workpiece on table to cut wall contact edge to desired length. Always make sure that cut workpiece length **at the back of the workpiece** is the same as wall length. Adjust cut length for angle of cut. Always use several pieces for test cuts to check the saw angles.

When cutting crown and cove moldings, set the bevel angle and miter angle as indicated in the table (A) and position the moldings on the top surface of the saw base as indicated in the table (B).

In the case of left bevel cut

Table (A)

	Molding position in Fig. A	Bevel angle		Miter angle	
		52/38° type	45° type	52/38° type	45° type
For inside corner	(1)	Left 33.9°	Left 30°	Right 31.6°	Right 35.3°
	(2)			Left 31.6°	Left 35.3°
For outside corner	(3)				
	(4)				

006361

Table (B)

	Molding position in Fig. A	Molding edge against guide fence	Finished piece
For inside corner	(1)	Ceiling contact edge should be against guide fence.	Finished piece will be on the Left side of blade.
	(2)	Wall contact edge should be against guide fence.	
For outside corner	(3)	Wall contact edge should be against guide fence.	Finished piece will be on the Right side of blade.
	(4)	Ceiling contact edge should be against guide fence.	

006362

Example:

In the case of cutting 52/38° type crown molding for position (1) in Fig. A:

- Tilt and secure bevel angle setting to 33.9° LEFT.
- Adjust and secure miter angle setting to 31.6° RIGHT.
- Lay crown molding with its broad back (hidden) surface down on the turn base

with its CEILING CONTACT EDGE against the guide fence on the saw.

- The finished piece to be used will always be on the LEFT side of the blade after the cut has been made.

In the case of right bevel cut

Table (A)

	Molding position in Fig. A	Bevel angle		Miter angle	
		52/38° type	45° type	52/38° type	45° type
For inside corner	(1)	Right 33.9°	Right 30°	Right 31.6°	Right 35.3°
	(2)			Left 31.6°	Left 35.3°
For outside corner	(3)				
	(4)				

006363

Table (B)

	Molding position in Fig. A	Molding edge against guide fence	Finished piece
For inside corner	(1)	Wall contact edge should be against guide fence.	Finished piece will be on the Right side of blade.
	(2)	Ceiling contact edge should be against guide fence.	
For outside corner	(3)	Wall contact edge should be against guide fence.	Finished piece will be on the Left side of blade.
	(4)	Ceiling contact edge should be against guide fence.	

006364

Example:

In the case of cutting 52/38° type crown molding for position (1) in Fig. A:

- Tilt and secure bevel angle setting to 33.9° RIGHT.
- Adjust and secure miter angle setting to 31.6° RIGHT.
- Lay crown molding with its broad back (hidden) surface down on the turn base with its WALL CONTACT EDGE against the guide fence on the saw.
- The finished piece to be used will always be on the RIGHT side of the blade after the cut has been made.

Crown molding stoppers (optional accessories) allow easier cuts of crown molding without tilting the saw blade. Install them on the base as shown in the figures.

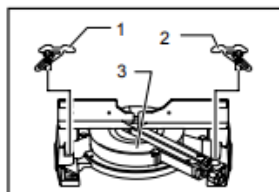

009521

1. Crown molding stopper L (Optional accessory)
2. Crown molding stopper R (Optional accessory)
3. Turn base

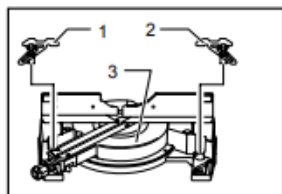

1. Crown molding stopper L
2. Crown molding stopper R
3. Turn base

009522

Fig. B: At right 45° miter angle

Fig. C: At left 45° miter angle

Position crown molding with its WALL CONTACT EDGE against the guide fence and its CEILING CONTACT EDGE against the crown molding stoppers as shown in the figure. Adjust the crown molding stoppers according to the size of the crown molding. Tighten the screws to secure the crown molding stoppers. Refer to the table (C) for the miter angle.

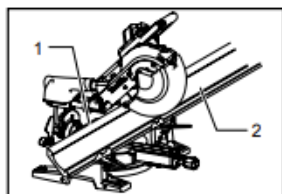

1. Guide fence
2. Crown molding

009520

Table (C)

	Position in Fig. A	Miter angle	Finished piece
For inside corner	(1)	Right 45°	Save the right side of blade
	(2)	Left 45°	Save the left side of blade
For outside corner	(3)		Save the right side of blade
	(4)	Right 45°	Save the left side of blade

006365

7. Cutting aluminum extrusion

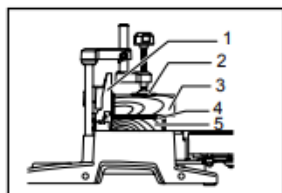

1. Guide fence
2. Vise
3. Spacer block
4. Aluminum extrusion
5. Spacer block

009523

When securing aluminum extrusions, use spacer blocks or pieces of scrap as shown in the figure to prevent deformation of the aluminum. Use a cutting lubricant when cutting the aluminum

extrusion to prevent build-up of the aluminum material on the blade.

⚠WARNING:

- Never attempt to cut thick or round aluminum extrusions. Thick or round aluminum extrusions can be difficult to secure and may work loose during the cutting operation which may result in loss of control and serious personal injury.

8. Wood facing

Use of wood facing helps to assure splinter-free cuts in workpieces. Attach a wood facing to the guide fence using the holes in the guide fence and 6 mm screws.

See the figure concerning the dimensions for a suggested wood facing.

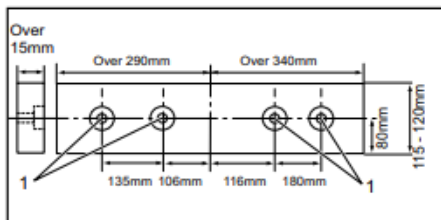

1. Hole

010046

⚠CAUTION:

- Use straight wood of even thickness as the wood facing.
- In order to completely cut through workpieces with a height of 102 mm to 120mm a wood facing should be used on the guide fence. The wood facing will space the workpiece away from the fence allowing the blade to complete a deeper cut.

Example:

When cutting workpieces 115 mm and 120 mm high, use a wood facing with the following thickness.

Miter angle	Thickness of wood facing	
	115 mm	120 mm
0°	35 mm	60 mm
Left and Right 45°	30 mm	45 mm
Left and Right 52°	25 mm	35 mm
Right 60°	25 mm	35 mm

010048

⚠WARNING:

- Use screws to attach the wood facing to the guide fence. The screws should be installed so that the screw heads are below the surface of the wood facing so that they will not

interfere with the positioning of the material being cut. Misalignment of the material being cut can cause unexpected movement during the cutting operation which may result in a loss of control and serious personal injury.

NOTICE:

- When the wood facing is attached, do not turn the turn base with the handle lowered. The blade and/or the wood facing will be damaged.

9. Groove cutting

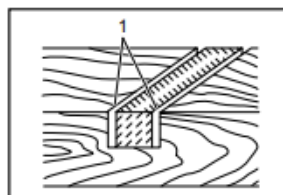

001563

1. Cut grooves with blade

A dado type cut can be made by proceeding as follows:

Adjust the lower limit position of the blade using the adjusting screw and the stopper arm to limit the cutting depth of the blade. Refer to "Stopper arm" section described previously.

After adjusting the lower limit position of the blade, cut parallel grooves across the width of the workpiece using a slide (push) cut as shown in the figure. Then remove the workpiece material between the grooves with a chisel.

⚠WARNING:

- Do not attempt to perform this type of cut by using a wider type blade or dado blade. Attempting to make a groove cut with a wider blade or dado blade could lead to unexpected cutting results and kickback which may result in serious personal injury.
- Be sure to return the stopper arm to the original position when performing other than groove cutting. Attempting to make cuts with the stopper arm in the incorrect position could lead to unexpected cutting results and kickback which may result in serious personal injury.

10. Special Max Width Cutting Capacities Technique

The maximum width cutting capacity of this tool can be achieved by following the steps below: For the maximum cutting width of this tool refer to the SPECIFICATIONS under "Special Max Width Cutting Capacities"

- Set the tool at 0° or 45° miter angle and make sure that the turn base is locked.

(Refer to the section titled "Adjusting the miter angle".)

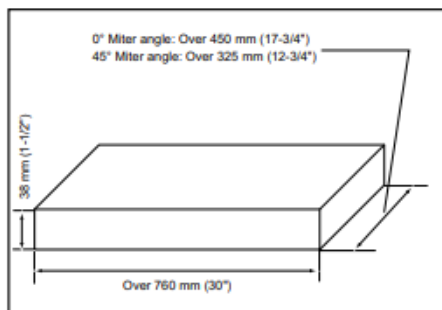

010565

- Remove both right and left upper fences temporarily and set aside
- Cut a platform to the dimensions indicated in the drawing above using a 38mm thick, flat stock material such as wood, plywood or particle board.

⚠WARNING:

- Be sure to use flat stock as a platform. Stock that is not flat may move during the cutting operation which may result in kickback and serious personal injury.

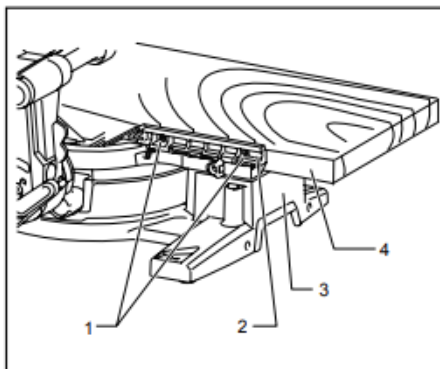

- Screws (two each side)
- Lower fence
- Base
- Platform

010357

NOTE:

- The maximum cutting capacity in height will be reduced by the same amount as the platform thickness.

- (4) Place the platform on the tool so that it extends equally over each side of the tool base.

Secure the platform to the tool using four 6 mm wood screws through four holes in the lower fences.

⚠WARNING:

- **Make sure that the platform is laying flat against the tool base and secured firmly to the lower fences using the four screw holes provided.** Failure to properly secure the platform may result in movement and possible kickback resulting in serious personal injury.
- **Ensure that the tool is firmly mounted to a stable and flat surface.** Failure to properly mount and secure the tool could cause the tool to be unstable resulting in a loss of control and/or the tool falling which may result in serious personal injury.

- (5) Install both of the removed upper fences on the tool.

⚠WARNING:

- **Do not use the tool without upper fences installed.** The upper fences provide the adequate support required to cut the workpiece. If the workpiece is not supported properly it may move resulting in possible loss of control, kickback and serious personal injury.

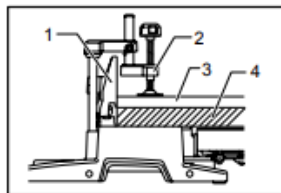

1. Upper fence
2. Vertical vise
3. Workpiece
4. Platform

010356

- (6) Place the workpiece to be cut on the platform secured to the tool.
- (7) Secure the workpiece firmly against the upper fences with a vise before cutting.
- (8) Make a cut through the workpiece slowly according to the operation titled "Slide (push) cutting (cutting wide workpieces)."

⚠WARNING:

- **Ensure that the workpiece is secured with the vise and make the cut slowly.** Failure to properly secure the workpiece and to cut slowly may cause the workpiece to move resulting in possible kickback and serious personal injury.

- **Beware that after several cuts are performed at various miter angles the platform may become weakened.** If the platform becomes weakened due to the multiple kerf cuts left in the material the platform should be replaced. If the weakened platform is not replaced it may cause the workpiece to move, during cutting, resulting in possible kickback and serious personal injury.

Carrying tool

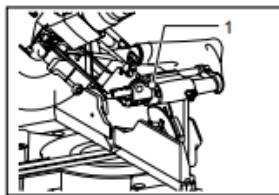

009483

1. Stopper pin

Make sure that the tool is unplugged. Secure the blade at 0° bevel angle and the turn base at the full right miter angle position. Secure the slide poles so that the lower slide pole is locked in the position of the carriage fully pulled to operator and the upper poles are locked in the position of the carriage fully pushed forward to the guide fence (refer to the section titled "Slide lock adjustment".) Lower the handle fully and lock it in the lowered position by pushing in the stopper pin.

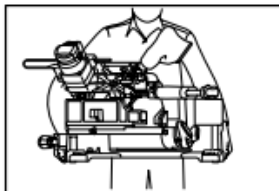

009506

⚠WARNING:

- **Stopper pin is only for carrying and storage purposes and should never be used for any cutting operations.** The use of the stopper pin for cutting operations may cause unexpected movement of the saw blade resulting in kickback and serious personal injury.

Carry the tool by holding both sides of the tool base as shown in the figure. If you remove the holders, dust bag, etc., you can carry the tool more easily.

⚠CAUTION:

- Always secure all moving portions before carrying the tool. If portions of the tool move or slide while being carried loss of control or balance may occur resulting in personal injury.

MAINTENANCE

⚠WARNING:

- Always be sure that the tool is switched off and unplugged before attempting to perform inspection or maintenance. Failure to unplug and switch off the tool may result in accidental start up of the tool which may result in serious personal injury.
- Always be sure that the blade is sharp and clean for the best and safest performance. Attempting a cut with a dull and /or dirty blade may cause kickback and result in a serious personal injury.

NOTICE:

- Never use gasoline, benzene, thinner, alcohol or the like. Discoloration, deformation or cracks may result.

Adjusting the cutting angle

This tool is carefully adjusted and aligned at the factory, but rough handling may have affected the alignment. If your tool is not aligned properly, perform the following:

1. Miter angle

Push the carriage toward the guide fence and tighten the locking screw clockwise and pull the lock lever towards the front of the saw to secure the carriage.

Turn the grip counterclockwise which secures the turn base. Turn the turn base so that the pointer points to 0° on the miter scale. Then turn the turn base slightly clockwise and counterclockwise to seat the turn base in the 0° miter notch. (Leave as it is if the pointer does not point to 0°.) Loosen the hex socket bolts securing the guide fence using the socket wrench.

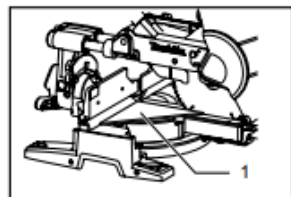

1. Triangular rule

009509

Lower the handle fully and lock it in the lowered position by pushing in the stopper pin. Square the side of the blade with the face of the guide fence using a triangular rule, try-square, etc. Then securely tighten the hex socket bolts on the guide fence in order starting from the right side.

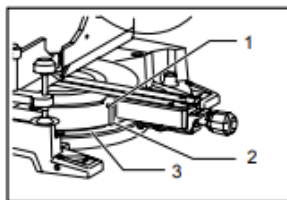

1. Screw
2. Pointer
3. Miter scale

009525

Make sure that the pointer points to 0° on the miter scale. If the pointer does not point to 0°, loosen the screw which secures the pointer and adjust the pointer so that it will point to 0°.

2. Bevel angle

Push the latch lever forward fully to release the positive stops.

(1) 0° bevel angle

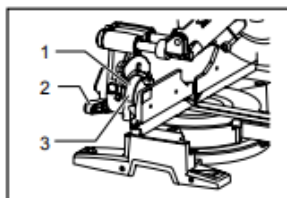

1. Pointer
2. Lever
3. Bevel scale plate

009512

Push the carriage toward the guide fence and tighten the locking screw clockwise and pull the lock lever towards the front of the saw to secure the carriage. Lower the handle fully and lock it in the lowered position by pushing in the stopper pin. Loosen the lever at the rear of the tool.

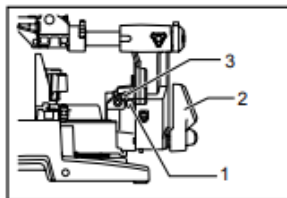

1. 0° Angle adjusting bolt
2. Lever
3. Latch lever

009511

Turn the hex socket bolt on the right side of the arm holder two or three revolutions counterclockwise to tilt the blade to the right.

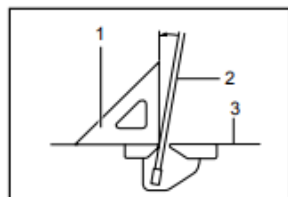

1. Triangular rule
2. Saw blade
3. Top surface of turn table

001819

Carefully square the side of the blade with the top surface of the turn base using the triangular rule, try-square, etc. by turning the hex socket bolt on the right side of the arm holder clockwise. Then tighten the lever securely.

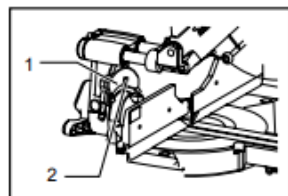

1. Bevel scale plate
2. Pointer

009490

Make sure that the pointers on the arm holder point to 0° on the bevel scale plate on the arm. If they do not point to 0°, loosen the screws which secure the pointers and adjust them so that they will point to 0°.

(2) 45° bevel angle

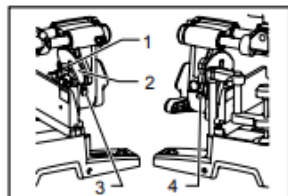

1. Pointer
2. Scale plate
3. Left 45° bevel angle adjusting bolt
4. Right 45° bevel angle adjusting bolt

009608

Adjust the 45° bevel angle only after performing 0° bevel angle adjustment. To adjust left 45° bevel angle, loosen the lever and tilt the blade to the left fully. Make sure that the pointer on the arm holder points to 45° on the bevel scale on the arm. If the pointer does not point to 45°, turn the left 45° bevel angle adjusting bolt on the side of the arm until the pointer points to 45°. To adjust right 45° bevel angle, perform the same procedure described above.

Adjustment of the laser line position

For models LS1216L and LS1216FL only

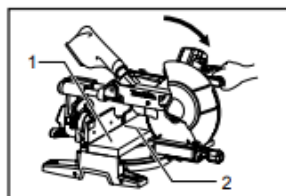

1. Workpiece
2. Laser line

009526

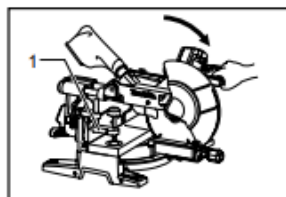

1. Vertical vise

009527

⚠WARNING:

- Since the tool must be plugged in while adjusting the laser line, special care must be taken to not switch on the tool. Accidental start up of the tool may result in serious personal injury.

⚠CAUTION:

- Never look directly into the laser beam. Direct eye exposure to the beam could cause serious damage to the eyes.
- LASER RADIATION
Do not stare into beam.

NOTICE:

- Beware that impacts to the tool may cause the laser line to be misaligned or may cause damage to the laser, shortening its life.

Adjusting the laser line for the left side of the blade.

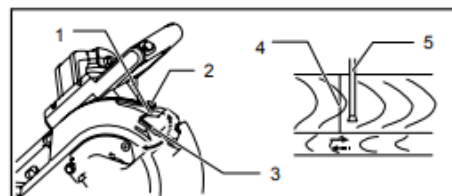

1. Screw to change the movable range of the adjusting screw
2. Adjusting screw
3. Hex wrench
4. Laser line
5. Saw blade

009514

Adjusting the laser line for the right side of the blade.

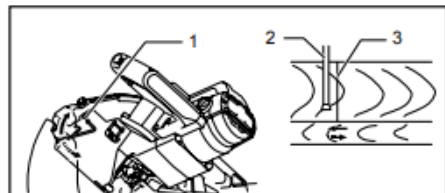

1. Adjusting screw
2. Saw blade
3. Laser line

009515

For both adjustments, do as follows.

1. Make sure that the tool is unplugged.
2. Draw the cutting line on the workpiece and place it on the turn table. At this time, do not secure the workpiece with a vise or similar securing device.
3. Lower the blade by lowering the handle and just check to see where the cutting line and the position of the saw blade is. (Decide which position to cut on the line of cut.)
4. After deciding the correct position of the line in relation to the blade, return the handle to the original position. Secure the workpiece with the vertical vise without shifting the workpiece from the pre-checked position.
5. Plug the tool and turn on the laser switch.
6. Adjust the position of laser line as follows.

The position of laser line can be changed as the movable range of the adjusting screw for the laser is changed by turning two screws with a hex wrench. (The movable range of laser line is factory adjusted within 1 mm from the side surface of blade.)

To shift the laser line movable range further away from the side surface of blade, turn the two screws counterclockwise after loosening the adjusting screw. Turn these two screws clockwise to shift it closer to the side surface of the blade after loosening the adjusting screw.

Refer to the section titled "Laser line action" and adjust the adjusting screw so that the cutting line on your workpiece is aligned with the laser line.

NOTE:

- Check the position of laser line regularly for accuracy.
- Have the tool repaired by a Makita authorized service center for any failure on the laser unit.

Cleaning the laser light lens

For models LS1216L and LS1216FL only

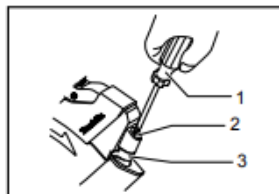

1. Screwdriver
2. Screw (one piece only)
3. Lens for the laser light

009609

If the lens for the laser light becomes dirty, or sawdust adheres to it in such a way that the laser line is no longer easily visible, unplug the saw and remove and clean the lens for the laser light carefully with a damp, soft cloth. Do not use solvents or any petroleum-based cleaners on the lens.

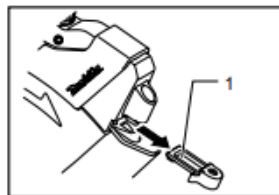

1. Lens for the laser light

009610

To remove the lens for the laser light, remove the saw blade before removing the lens according to the instructions in the section titled "Installing or removing saw blade".

Loosen but do not remove the screw which secures the lens using a screwdriver.

Pull out the lens as shown in the figure.

NOTE:

- If the lens does not come out, loosen the screw further and pull out the lens again without removing the screw.

Replacing carbon brushes

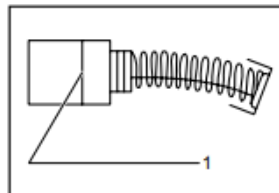

1. Limit mark

001145

Remove and check the carbon brushes regularly. Replace when they wear down to the limit mark. Keep the carbon brushes clean and free to slip in the holders.

Both carbon brushes should be replaced at the same time. Use only identical carbon brushes.

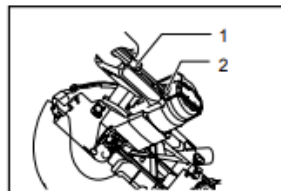

1. Screwdriver
2. Brush holder cap

009516

Use a screwdriver to remove the brush holder caps. Take out the worn carbon brushes, insert the new ones and secure the brush holder caps.

After replacing brushes, plug in the tool and break in brushes by running tool with no load for about 10 minutes. Then check the tool while running and electric brake operation when releasing the switch trigger. If the electric brake is not working correctly, have the tool repaired by a Makita service center

After use

- After use, wipe off chips and dust adhering to the tool with a cloth or the like. Keep the blade guard clean according to the directions in the previously covered section titled "Blade guard". Lubricate the sliding portions with machine oil to prevent rust.
- When storing the tool, pull the carriage toward you fully so that the slide pole is thoroughly inserted into the turn base.

To maintain product SAFETY and RELIABILITY, repairs, any other maintenance or adjustment should be performed by Makita Authorized Service Centers, always using Makita replacement parts.

OPTIONAL ACCESSORIES

⚠WARNING:

- **These Makita accessories or attachments are recommended for use with your Makita tool specified in this manual.** The use of any other accessories or attachments may result in serious personal injury.
- **Only use the Makita accessory or attachment for its stated purpose.** Misuse of an accessory or attachment may result in serious personal injury.

If you need any assistance for more details regarding these accessories, ask your local Makita Service Center.

- Steel & Carbide-tipped saw blades

Miter saw blades	For smooth and precise cutting in various materials.
Combination	General purpose blade for fast and smooth rip, crosscuts and miters.
Crosscutting	For smoother cross grain cuts. Slices cleanly against the grain.
Fine cross cuts	For sand-free cuts cleanly against the grain.
Non-ferrous metals miter saw blades	For miters in aluminum, copper, brass, tubing, and other non-ferrous metals.

006526

- Vise assembly (Horizontal vise)
- Vertical vise
- Hex wrench 6
- Socket wrench 13
- Holder
- Dust bag
- Crown molding stopper set
- Triangular rule
- Dust box
- Hex wrench (for LS1216L and LS1216FL)

NOTE:

- Some items in the list may be included in the tool package as standard accessories. They may differ from country to country.

Makita Corporation
Anjo, Aichi, Japan

www.makita.com