

ENGLISH

Nibbler

MODEL JN3200

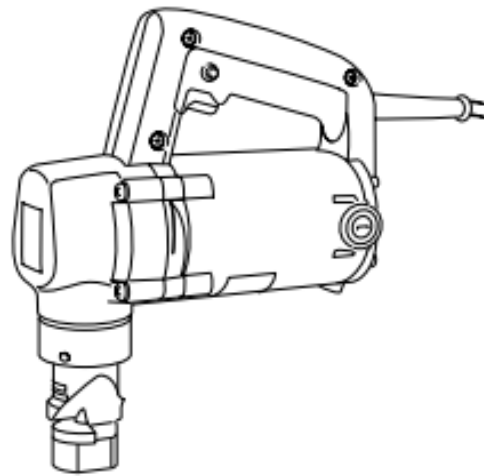

004773

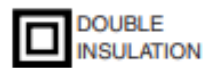

I N S T R U C T I O N M A N U A L

⚠ WARNING:
For your personal safety, READ and UNDERSTAND before using.
SAVE THESE INSTRUCTIONS FOR FUTURE REFERENCE.

SPECIFICATIONS

Model		JN3200
Max. cutting capacities	Steel up to 400 N/mm ²	3.2 mm / 10 ga
	Steel up to 600 N/mm ²	2.5 mm / 13 ga
	Steel up to 800 N/mm ²	1.0 mm / 20 ga
	Aluminum up to 200 N/mm ²	3.5 mm / 10 ga
Min. cutting radius	Outside edge	128 mm
	Inside edge	120 mm
Strokes per minute (min ⁻¹)		1,300
Overall length		215 mm
Net weight		3.4 kg
Safety class		□ / II

- Due to our continuing programme of research and development, the specifications herein are subject to change without notice.
- Note: Specifications may differ from country to country.

SYMBOLS

END201-2

The following show the symbols used for the equipment. Be sure that you understand their meaning before use.

 Read instruction manual.

 DOUBLE INSULATION

 Only for EU countries

Do not dispose of electric equipment together with household waste material!

In observance of European Directive 2002/96/EC on waste electric and electronic equipment and its implementation in accordance with national law, electric equipment that have reached the end of their life must be collected separately and returned to an environmentally compatible recycling facility.

Intended use

The tool is intended for cutting sheet steel and stainless sheet steel.

Power supply

The tool should be connected only to a power supply of the same voltage as indicated on the nameplate, and can only be operated on single-phase AC supply. They are double-insulated in accordance with European Standard and can, therefore, also be used from sockets without earth wire.

For European countries only

Noise and Vibration

The typical A-weighted noise levels are
 sound pressure level: 89 dB (A)
 sound power level: 100 dB (A)
 Uncertainty: 3 dB(A)

– Wear ear protection. –

The typical weighted root mean square acceleration value is not more than 2.5 m/s².

These values have been obtained according to EN60745.

EC-DECLARATION OF CONFORMITY

We declare under our sole responsibility that this product is in compliance with the following standards of standardized documents, EN60745, EN55014, EN61000 in accordance with Council Directives, 89/336/EEC, 98/37/EC.

Yasuhiko Kanzaki CE 2005



Director

MAKITA INTERNATIONAL EUROPE LTD.

Michigan Drive, Tongwell, Milton Keynes, Bucks MK15 8JD, ENGLAND

Responsible manufacturer:

Makita Corporation Anjo Aichi Japan

GENERAL SAFETY RULES

GEA001-3

WARNING:

Read all instructions. Failure to follow all instructions listed below may result in electric shock, fire and/or serious injury. The term “power tool” in all of the warnings listed below refers to your mains-operated (corded) power tool or battery-operated (cordless) power tool.

SAVE THESE INSTRUCTIONS

Work area safety

1. **Keep work area clean and well lit.** Cluttered and dark areas invite accidents.
2. **Do not operate power tools in explosive atmospheres, such as in the presence of flammable liquids, gases or dust.** Power tools create sparks which may ignite the dust or fumes.
3. **Keep children and bystanders away while operating a power tool.** Distractions can cause you to lose control.

Electrical safety

4. **Power tool plugs must match the outlet. Never modify the plug in any way. Do not use any adapter plugs with earthed (grounded) power tools.** Unmodified plugs and matching outlets will reduce risk of electric shock.
5. **Avoid body contact with earthed or grounded surfaces such as pipes, radiators, ranges and refrigerators.** There is an increased risk of electric shock if your body is earthed or grounded.
6. **Do not expose power tools to rain or wet conditions.** Water entering a power tool will increase the risk of electric shock.
7. **Do not abuse the cord. Never use the cord for carrying, pulling or unplugging the power tool. Keep cord away from heat, oil, sharp edges or moving parts.** Damaged or entangled cords increase the risk of electric shock.
8. **When operating a power tool outdoors, use an extension cord suitable for outdoor use.** Use of a cord suitable for outdoor use reduces the risk of electric shock.

Personal safety

9. **Stay alert, watch what you are doing and use common sense when operating a power tool. Do not use a power tool while you are tired or under the influence of drugs, alcohol or medication.** A moment of inattention while operating power tools may result in serious personal injury.

10. **Use safety equipment. Always wear eye protection.** Safety equipment such as dust mask, non-skid safety shoes, hard hat, or hearing protection used for appropriate conditions will reduce personal injuries.
11. **Avoid accidental starting. Ensure the switch is in the off-position before plugging in.** Carrying power tools with your finger on the switch or plugging in power tools that have the switch on invites accidents.
12. **Remove any adjusting key or wrench before turning the power tool on.** A wrench or a key left attached to a rotating part of the power tool may result in personal injury.
13. **Do not overreach. Keep proper footing and balance at all times.** This enables better control of the power tool in unexpected situations.
14. **Dress properly. Do not wear loose clothing or jewellery. Keep your hair, clothing, and gloves away from moving parts.** Loose clothes, jewellery or long hair can be caught in moving parts.
15. **If devices are provided for the connection of dust extraction and collection facilities, ensure these are connected and properly used.** Use of these devices can reduce dust-related hazards.

Power tool use and care

16. **Do not force the power tool. Use the correct power tool for your application.** The correct power tool will do the job better and safer at the rate for which it was designed.
17. **Do not use the power tool if the switch does not turn it on and off.** Any power tool that cannot be controlled with the switch is dangerous and must be repaired.
18. **Disconnect the plug from the power source and/or the battery pack from the power tool before making any adjustments, changing accessories, or storing power tools.** Such preventive safety measures reduce the risk of starting the power tool accidentally.

-
19. Store idle power tools out of the reach of children and do not allow persons unfamiliar with the power tool or these instructions to operate the power tool. Power tools are dangerous in the hands of untrained users.
 20. Maintain power tools. Check for misalignment or binding of moving parts, breakage of parts and any other condition that may affect the power tools operation. If damaged, have the power tool repaired before use. Many accidents are caused by poorly maintained power tools.
 21. Keep cutting tools sharp and clean. Properly maintained cutting tools with sharp cutting edges are less likely to bind and are easier to control.
 22. Use the power tool, accessories and tool bits etc. in accordance with these instructions and in

the manner intended for the particular type of power tool, taking into account the working conditions and the work to be performed. Use of the power tool for operations different from those intended could result in a hazardous situation.

Service

23. Have your power tool serviced by a qualified repair person using only identical replacement parts. This will ensure that the safety of the power tool is maintained.
24. Follow instruction for lubricating and changing accessories.
25. Keep handles dry, clean and free from oil and grease.

ADDITIONAL SAFETY RULES FOR TOOL

ENB073-1

1. Hold the tool firmly.
2. Secure the workpiece firmly.
3. Keep hands away from moving parts.
4. Edges and chips of the workpiece are sharp. Wear gloves. It is also recommended that you put on thickly bottomed shoes to prevent injury.
5. Do not put the tool on the chips of the workpiece. Otherwise it can cause damage and trouble on the tool.
6. Do not leave the tool running. Operate the tool only when hand-held.
7. Always be sure you have a firm footing. Be sure no one is below when using the tool in high locations.
8. Do not touch the punch, die or the workpiece immediately after operation; they may be extremely hot and could burn your skin.
9. Avoid cutting electrical wires. It can cause serious accident by electric shock.

SAVE THESE INSTRUCTIONS

FUNCTIONAL DESCRIPTION

⚠ CAUTION:

- Always be sure that the tool is switched off and unplugged before adjusting or checking function on the tool.

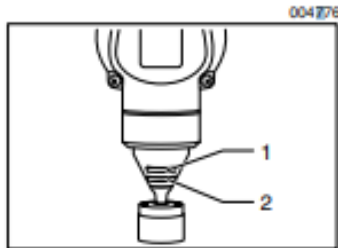

1. Stainless steel gauge 2.5 mm (3/32")
2. Mild steel gauge 3.2 mm (1/8")

Permissible cutting thickness

The thickness of material to be cut depends upon the tensile strength of the material itself. The groove on the die holder acts as a thickness gauge for allowable cutting thickness. Do not attempt to cut any material which will not fit into this groove.

006439		
Max. cutting capacities	mm	ga
Steel up to 400 N/mm ²	3.2	10
Steel up to 600 N/mm ²	2.5	13
Steel up to 800 N/mm ²	1.0	20
Aluminum up to 200 N/mm ²	3.5	10

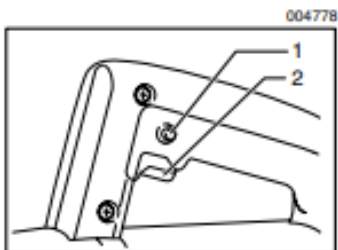

1. Lock button
2. Switch trigger

Switch action

⚠ CAUTION:

- Before plugging in the tool, always check to see that the switch trigger actuates properly and returns to the "OFF" position when released.

To start the tool, simply pull the switch trigger. Release the switch trigger to stop.

For continuous operation, pull the switch trigger and then push in the lock button.

To stop the tool from the locked position, pull the switch trigger fully, then release it.

ASSEMBLY

⚠ CAUTION:

- Always be sure that the tool is switched off and unplugged before carrying out any work on the tool.

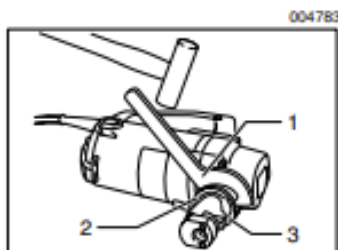

1. Wrench
2. Lock nut
3. Die holder

Punch replacement

Fit the wrench provided onto the lock nut and tap the handle lightly with a hammer to loosen the lock nut. Take off the die holder and use a wrench to remove the screw. Then remove the punch.

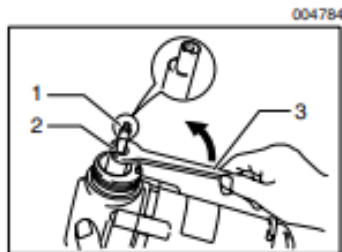

004784

To install the punch, insert it into the punch holder with its cutting edge facing forward so that the pin in the punch holder fits into the groove in the punch. Install the screw and lock nut. Then tighten them securely.

1. Punch
2. Screw
3. Wrench

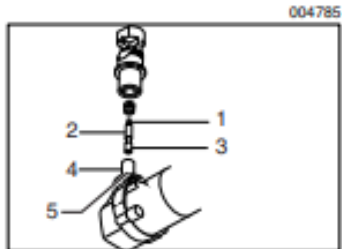

004785

NOTE:

- When installing the screw and lock nut, be sure to tighten securely. If they become loose during operation, the tool may break down.

1. Cutting edge
2. Punch
3. Groove
4. Punch holder
5. Pin

OPERATION

Pre-lubrication

Coat the cutting line with machine oil to increase the punch and die service life. This is particularly important when cutting aluminum.

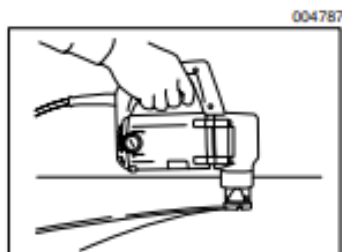

004787

Cutting method

Smooth cutting is achieved by holding the tool upright and applying gentle pressure in the cutting direction.

Apply tool oil to the punch about every 10 meters of mild steel or stainless steel to be cut. Light oil or kerosene should be used to keep an aluminum lubricated continuously. Failure to lubricate aluminum in the cut will cause chips to adhere to the tool, dulling the die and punch and increasing load on the motor.

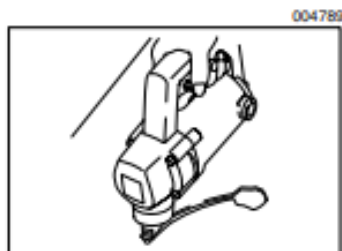

004789

Cutouts

Cutouts can be done by first opening a round hole of about 42 mm diameter or more in the material.

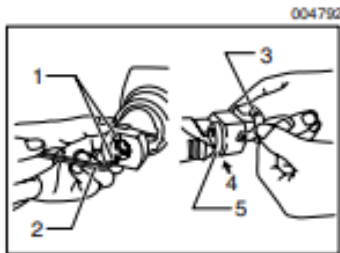

1. Screw
2. Hex wrench
3. Washer
4. Insert washer in between
5. Die

Cutting stainless steel

There is more vibration when cutting stainless steel than mild steel. Less vibration and better cutting is possible by adding another washer (standard equipment) beneath the die.

Use the hex wrench provided to remove the two screws and insert the washer below the die. Replace screws and tighten securely.

MAINTENANCE

⚠ CAUTION:

- Always be sure that the tool is switched off and unplugged before attempting to perform inspection or maintenance.

Punch & die service life

Replace or sharpen punch and die after cutting the lengths indicated in the accompanying table. Their life, of course, depends upon the thickness of materials cut and lubrication conditions.

006441	
Punch	Replace after 150 m of 3.2 mm steel sheet
Die	Sharpen after 300 m of 3.2 mm steel sheet

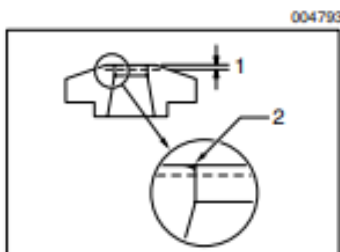

1. Grind/sharpen; 0.3 - 0.4 mm (1/64")
2. Remove dull portion

When cutting is poor even after replacing the punch, sharpen the die. Grind down the dull edge shown in the figure using a grinder. After rough-grinding the dull portion, finish with a dressing stone. Stock removal should be about 0.3 to 0.4 mm.

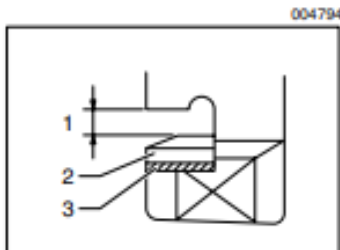

1. 3.5 -4.0 mm (1/8" - 5/32")
2. Die
3. Washer

When installing ground die, a clearance of 3.5 to 4.0 mm should be obtained by attaching one or two of the washer provided, as shown in the figure. Failure to have the proper clearance will result in vibration during cutting.

⚠ CAUTION:

- Secure installing screws carefully when installing. A loose screw can cause tool breakage during operation.

NOTE:

- The die can be sharpened two times. After two sharpenings, it should be replaced with new one.

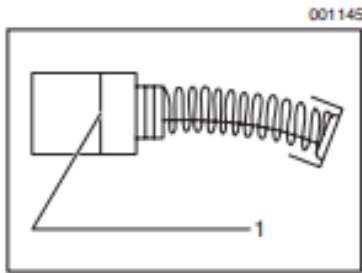

001145

Replacing carbon brushes

Remove and check the carbon brushes regularly. Replace when they wear down to the limit mark. Keep the carbon brushes clean and free to slip in the holders. Both carbon brushes should be replaced at the same time. Use only identical carbon brushes.

1. Limit mark

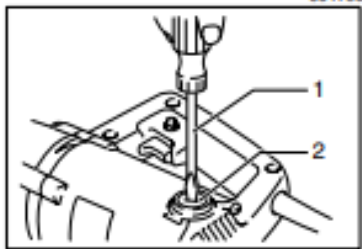

004796

Use a screwdriver to remove the brush holder caps. Take out the worn carbon brushes, insert the new ones and secure the brush holder caps.

To maintain product SAFETY and RELIABILITY, repairs, any other maintenance or adjustment should be performed by Makita Authorized Service Centers, always using Makita replacement parts.

1. Screwdriver

2. Brush holder cap

ACCESSORIES

⚠ CAUTION:

- These accessories or attachments are recommended for use with your Makita tool specified in this manual. The use of any other accessories or attachments might present a risk of injury to persons. Only use accessory or attachment for its stated purpose.

If you need any assistance for more details regarding these accessories, ask your local Makita service center.

- Die
- Punch
- Hex wrench
- Wrench 50
- Die height adjustment washer

Makita Corporation Anjo, Aichi, Japan